



KURZ – making every product unique

Высокое качество отделки требует
высокого качества всего процесса

KURZ - оптимальные решения

- машины
- инструменты

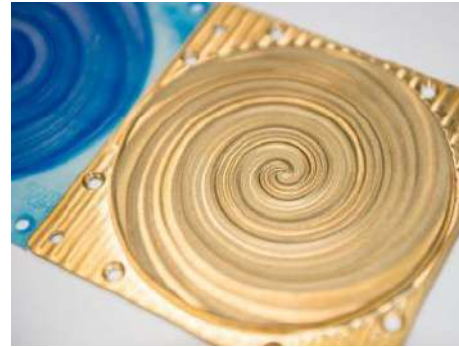

01

**Digital
Embellishment**



2014

Презентация
DM-LINER



2022

KURZ Digital Embellishment solutions



TRANSFER ON TONER



DM Luxliner
(SRA3 – B2)



- Commercial
- Light Packaging

DM Smartliner
(SRA3 – B2)



- Commercial
- Light Packaging



DM Maxliner 2D
(SRA3 – B2)



- Commercial
- Web2Print
- Packaging
- Web2Pack



DM Maxliner 3D
(B2 – B1)



- Commercial
- Web2Print
- Packaging
- Web2Pack

STEINEMANN DPE
DM Flexliner W



For Gallus
gallus

- Labels

STEINEMANN DPE
DM Flexliner 3D



For Gallus **Labelfire**
gallus

- Labels
- Packaging

KURZ
DM Flexliner 2D



For Conventional Flexo
machines

- Labels

KURZ
DM Jetliner 2D



For Indigo 6x00



- Labels

KURZ
DM Uniliner 2D



Stand alone solution

- Labels

STEINEMANN DPE
DM Uniliner 3D



Stand alone solution

- Labels

02

DM-SMARTLINER



DM-SMARTLINER



DM Smartliner
(SRA3 – B2)

Entry level solution

Minimum JOB SIZE is ONE SHEET!!!

Speed up to 25 mts/min

Working on all toner / electro-ink pre-printed designs

Digital overprinting possible (to achieve endless range of metallic shades)

DM-SMARTLINER; упаковка

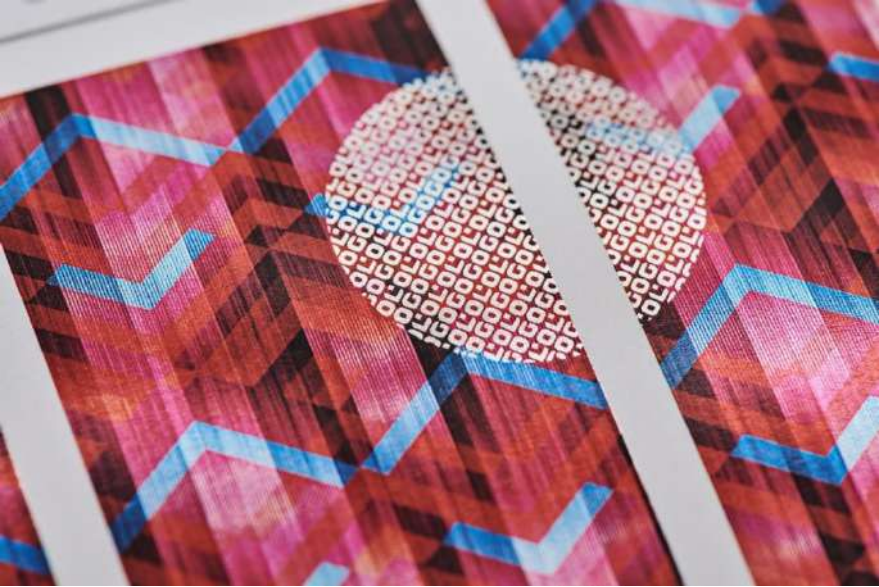

DM-SMARTLINER; блокноты



03

**DM-JETLINER 2D
DM-UNILINER**



DM-JETLINER / DM-UNILINER 2D

1. Generation - Product Launch Drupa 2016



2. Generation - Product Launch



**LABELEXPO
EUROPE 2019**



DM-JETLINER



DM-UNILINER 2D



Field proven technology

Add metallization - add value to your products

Inline solution

Keep your process workflow without adding an production step

Flexibility for your production

High level of automation

DM-JETLINER / DM-UNILINER 2D

Amberley Labels installs KURZ DM-JETLINER

installs Kurz



Lucas Étiquettes installs KURZ DM-JETLINER



This machine offers the production speed of the digital printing technologies.
<https://lnkd.in/dsvp2WD> for this solution and our other technologies.
 #kurzusa #digitaldecoration #labeldecoration #digitalmetal



"The DM-JETLINER has been a huge advantage for us. We are more than pleased with our purchase. And the support we've received from both KURZ and HP made the install a smooth process"

Mike Wolf,
Owner of Label Specialties



ZUR ÜBERSICHT

12.09.2019

Kurz delivers digital embellishment at All4Labels

Introduced earlier this year, the DM-Jetliner can be easily integrated into existing production lines. Quality labels with metallic effects and embossed patterns are produced. Production is available for all label formats and the application of the KURZ Digital Metal (DM) decoration on the PET carrier is possible.

The system can be retrofitted into existing presses running at the speed of 8000 labels per minute and an HP Indigo 8000.

Roger Gehrke, executive vice president of All4Labels, explains: "The idea behind the DM-Jetliner is to create metallic colors and effects, which was preprinted, wasteful and required a lot of color required, as well as the DM-Jetliner allows us to produce metallic effects and embossed patterns on labels." The DM-Jetliner is a next-generation digital printing technology that extensively uses narrow web HP Indigo ink application, allowing custom metallic effects through the use of Digital Metal (DM) decoration to complement the Jetliner's capabilities.

The DM-Jetliner is a next-generation digital printing technology that extensively uses narrow web HP Indigo ink application, allowing custom metallic effects through the use of Digital Metal (DM) decoration to complement the Jetliner's capabilities.

The DM-Jetliner is a next-generation digital printing technology that extensively uses narrow web HP Indigo ink application, allowing custom metallic effects through the use of Digital Metal (DM) decoration to complement the Jetliner's capabilities.



EUROSTAMPA installs KURZ DM-JETLINER



The Kurz DM-Jetliner unit has been installed in the Eurostampa plant with a HP Indigo 8000 series digital press. The Kurz DM-Jetliner unit has been installed in the Eurostampa plant with a HP Indigo 8000 series digital press. The Kurz DM-Jetliner unit has been installed in the Eurostampa plant with a HP Indigo 8000 series digital press.



Die Labelisten installs KURZ DM-UNILINER

DM-JETLINER / DM-UNILINER 2D

Тонкие материалы



Стандартные материалы



Текстурированные материалы



От термоусадочных пленок ...

... до мелованных и немелованных бумаг

ПРИМЕРЫ РАБОТ



Различные дизайны для разных месяцев продаж



Тонкие детали декора



Разные города – серебрянный металл

ПРИМЕРЫ РАБОТ



BRAVO BREWING – цифровая металлизация для термоусадочной этикетки



REAL CASES



Переменные данные – тонкие детали

Металлизация с последующей запечаткой metallization



HP Indigo Mosaic для металлизации и последующей запечатки



04

DM-MAXLINER 3D



DM-MAXLINER 3D

Скоростное решение для листовой цифровой печати от KURZ - B1 и B2 формат



Лак и фольга в 1 прогон

Максимальное качество: 600 x 600 dpi

Максимальная скорость: 10'000 листов / час лак
5'000 листов / час металлизация

Быстрая смена тиражей (IMC)

Полное решение от Leonhard KURZ

Экономия фольги

DM-MAXLINER 3D

DM-unit

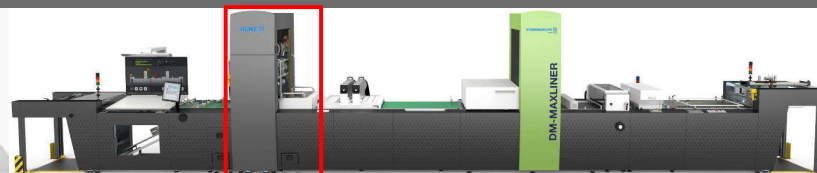
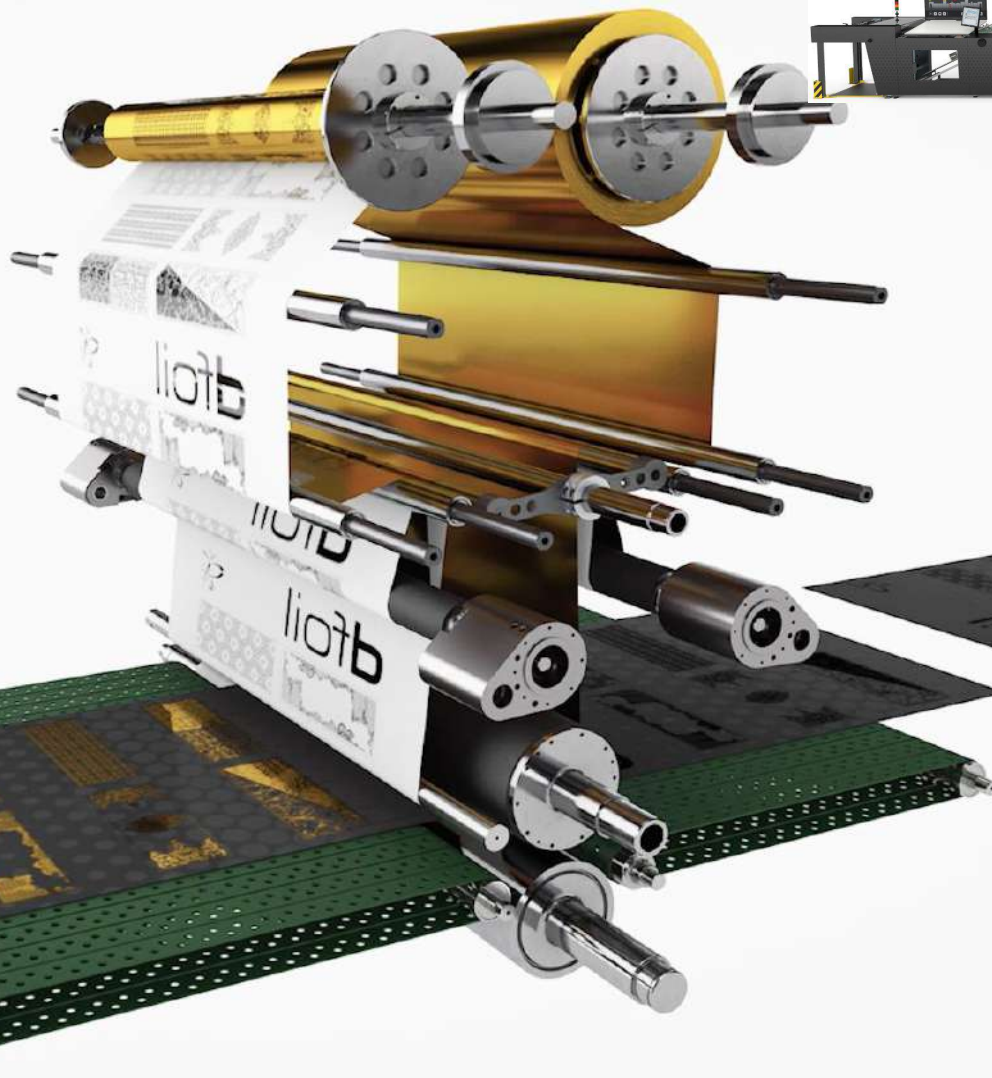

DM-unit

- Самая быстрая металлизация
- до 40 м/мин – скорость декорирования фольгой
- Самая эффективная система экономии фольги

DM-MAXLINER 3D

Digital inkjet varnishing unit – basic machine



Digital inkjet unit –
базовая версия

- 1 ряд печатных головок
- Разрешение до 600 dpi
- От 4 до 50 микрон
- Скорость лакирования до 6'400 листов В1

DM-MAXLINER 3D

Образцы



Job explanation

1. Book cover "Behind the wall"
2. Magazine cover "Style"
3. Magazine cover "fine"
4. Packaging "Bourbon Lunar"
5. Commercial "Menu card"
6. Packaging "Ophelia lotion"
7. Packaging "Gift voucher"
8. Commercial "VIP ticket"
9. Commercial "Greeting cards"

DM-MAXLINER 3D

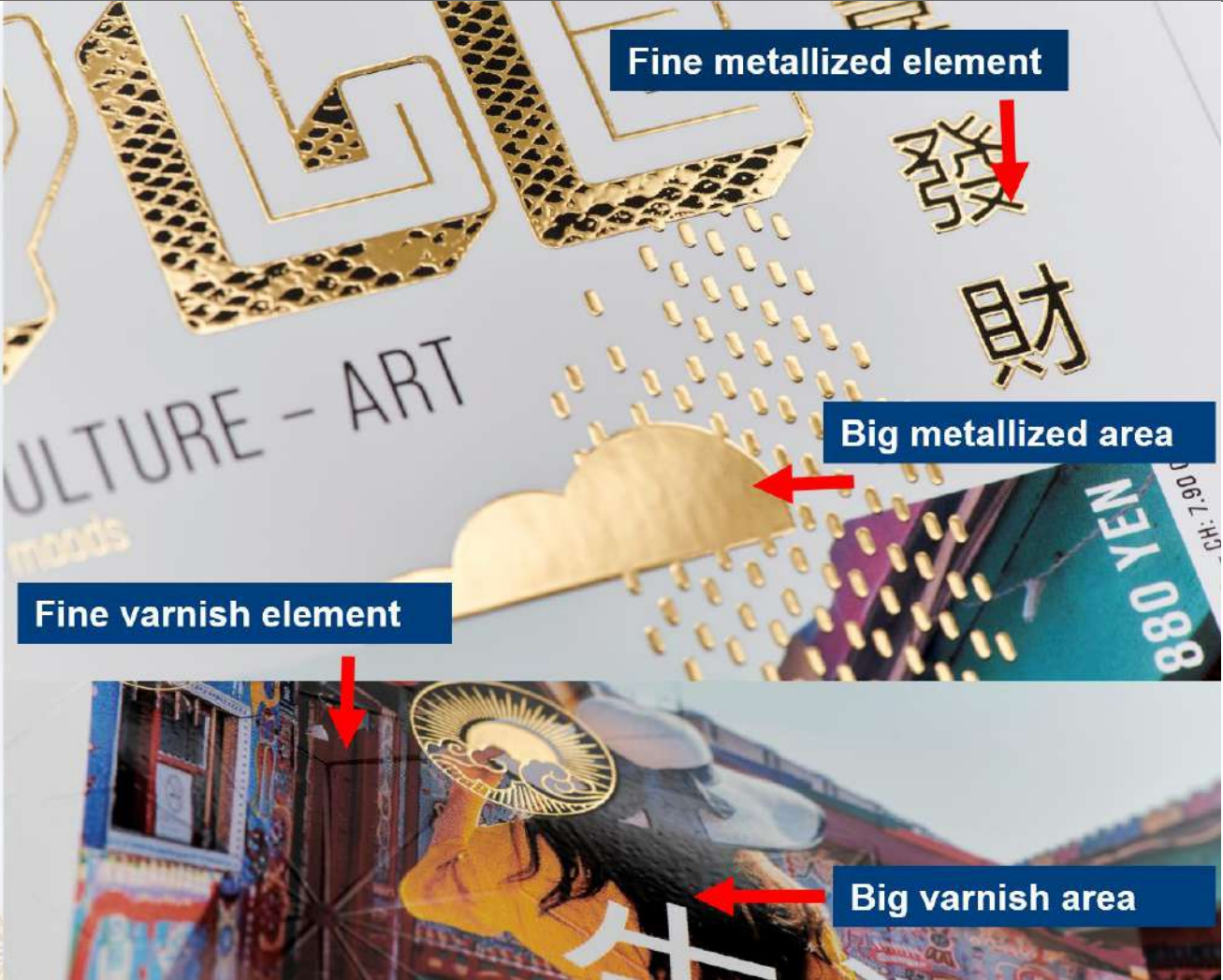
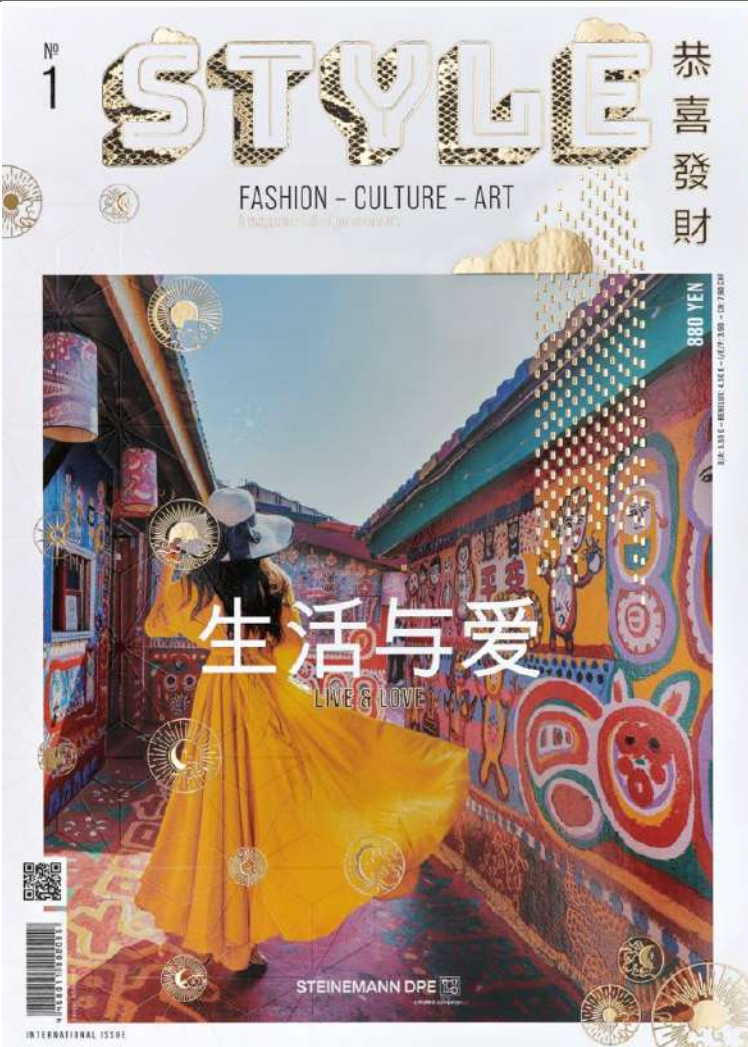

DM-MAXLINER 3D

Job calculation: 5. Commercial “Menu card”

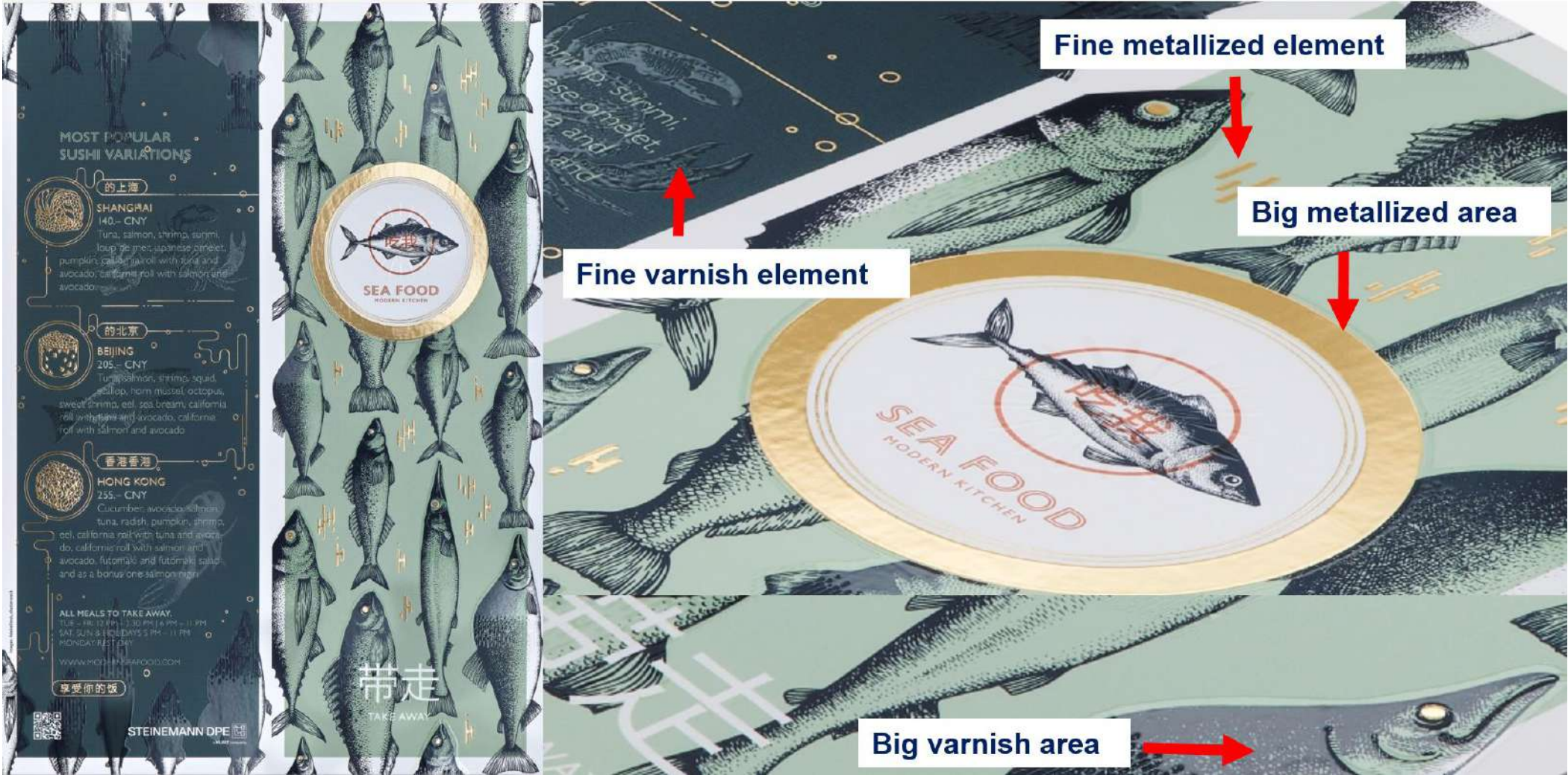

DM-MAXLINER 3D



05

DM-UNILINER 3D



DM-UNILINER 3D

Digital UV varnish and metallization on paper and plastics



SINGLE CONFIGURATION :

1 Application unit: UV Varnish or Metallization in each PASS

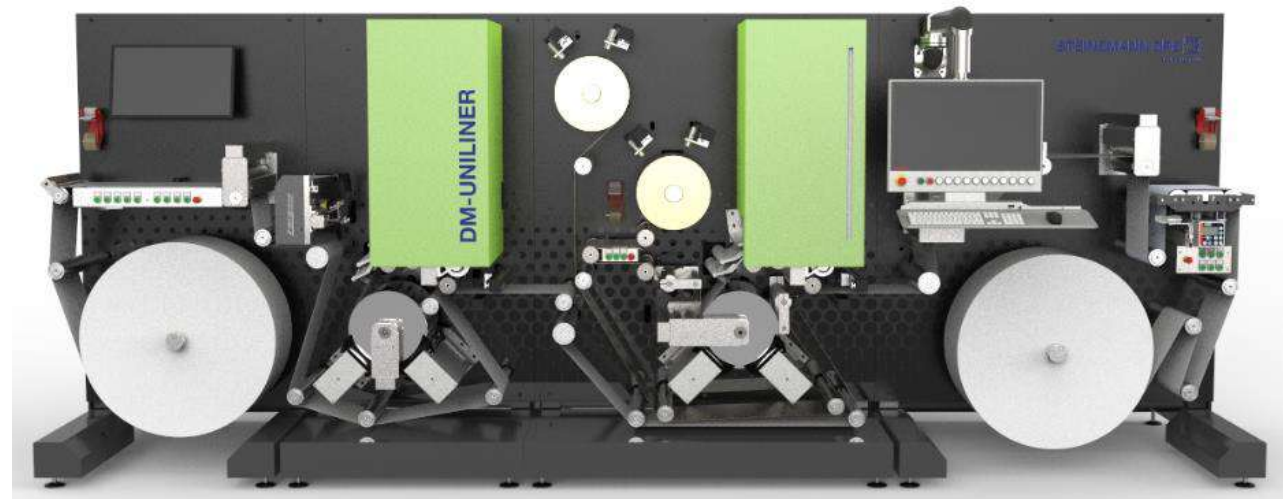

TWIN CONFIGURATION:

2 Application units: UV Varnish and Metallization in one single PASS

DM-UNILINER DIFFERENCES

DM-UNILINER 3D – DM-UNILINER 2D



	DM-UNILINER 2D	DM-UNILINER 3D
Inkjet technology	Ink on foil	Ink on substrate
Substitution of	Cold foil	Hot foil Screen printing Blind embossing
Varnish thickness g/m ²	1.7 – 8.1	4 - 100
Uncoated paper / Wine Customer individual testing recommended	++	+

DM-UNILINER 3D ПРИМЕРЫ РАБОТ

Вино: лак



DM-UNILINER 3D : ПРИМЕРЫ РАБОТ

Алкоголь: металлизация



DM-UNILINER 3D : ПРИМЕРЫ РАБОТ

Вино: лак и металлизация





www.kurz-world.com

Follow us on

